

# HS Automatic ApS

## High resolution industrial ink-jet printers



# INSTALLATION MANUAL

Manufacturer:  
HS Automatic ApS  
Bjerringbrovej 70  
DK-2610 Rødovre  
Denmark

Manual version: 0.7  
Last edited: 2003 nov 06 by Torben Dam Jensen.

This manual describes the unpacking, setup and installation of the industrial inkjet system w/ IPC controllers, using XaarJet 126, 128 and 500 print engines.

For documentation on older products and the terminal box, as well as technical service instructions, please see separate manuals.

For service requests please first contact your local distributor.

# Introduction

## The concept of HS Automatic ApS printing technology

The concept of the printing system is built around minimum 2 items:

- 1 Controller, which is used to generate the pictures
- 1 or more print heads (up to 16 max)

### The controller

You can choose between a controller board for your own office computer and a stainless steel computer (IPC). Each controller has 2 (optionally 4) printer outputs, with each output being able to control 4 XJ128 or 1 XJ 500 printer.



Figure 1 : IPC controller with 70mm XaarJet128 printer, shown in umbilical version.

### The printer

A printer consists of an ink supply and the print head. The ink supply has an automatic ink system with an ink bottle mounted below.

The head is mounted with either 1 XJ500 or 1 to 4 XJ 126/ 128 print engines. Both compact versions and umbilical versions (for printing on top of boxes for example) are available.

You can combine the printers any way you want, as long as you remember these rules:

- Each output supplies 70 mm of the total message height.
- You can use up to 4 engines of XJ126/ XJ128 or 1 engine of XJ500 per output on the IPC.

## List of features

The printers from HS Automatic ApS are modular, low-cost, low-maintenance and high resolution, based on the XaarJet piezo technology. Currently, we offer these print engines:

- XaarJet 126
- XaarJet 128
- XaarJet 500

Some of the features on the HS Automatic ApS print systems are

- Print height up to 280 mm, using any combination of either engine type.
- Print horizontal or vertical
- Print head mounted on the ink supply or with an umbilical of up to 1 m.
- Print controlled from object-oriented Windows® software *OBJ INKdraw*, allowing you an unlimited number of messages, and freely placeable and sizeable objects.
- Automatic ink system with ½ or 1 Liter bottles

# Installation

## Unpacking

When you receive the box, the first thing you should do is to check if the content of the box is the same as specified in your order and specified on the delivery note on the side of the box. Along with the equipment you have ordered, you will receive some accessories. Please check that these are also included in the box:

### IPC controller

- Set of manuals for the motherboard, including driver CDs
  - 9-pin F-F cable
  - 2 Extra plugs 9-pin M
  - For the USB version (without floppy drive): An USB memory key
  - If you purchased Windows® pre-installed: an original Windows® Embedded license sticker.
- 
-  Due to the different sizes and shapes of power cables around the world, we do not include a 220V (110V) power cable for the IPC. The IPC accepts a standard PC 3-legged female connector in the power supply

### Printers

- Purge Bulb with mounted tube and air filter
- Blue cotton swab
- 2 Syringes, 20 and 10 ml.
- Air filter
- 25 pin signal cable 1.8 m

### Terminal box

- 9 pin connection cable

### Accessories, if supplied from your distributor

- Encoder + encoder wheel, fitted with 9-pin cable
- Start sensor, either as photo cell or mechanical switch

## Placing the head on the conveyor

For non-compact heads it is important to mount the head in correct height compared to the ink supply, in order to avoid starvation or weeping of ink.

Below is a table showing the correct distances:

	Horizontal printing	Vertical printing
1 engine 17.5 mm	35-65 mm	49-79 mm
2 engines 35 mm	36-48 mm	49-79 mm
3 engines 52.5 mm	38-45 mm	84-114 mm
4 engines 70 mm		
Xaar 500 70 mm	32 mm	83-103 mm

### Distance to product

When you mount the head on the conveyor, it is important to know that the piezzo technology does not have the ability to fire very far. In fact, you should place the printhead in a position where it is *as close to the product as possible*. A distance of 1-2 mm will give a good print.

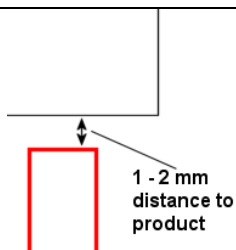

Figure 2: distance to product

Illustration of print distance to product, with the print head shown in red below.

Optimal distance is about 1 mm.

**⚠ The engines are fragile and sensitive to direct impact from the front. Be careful to mount the print head so that the engines are protected from products that may be out of alignment - for example by mounting a guard in front of the head. Heads damaged by impact are not covered by warranty !!**

## Angle

The print head can not only shoot directly horizontally, but in almost every other direction. The specifications say that you can print *up to 30° from vertical*.

Experience show that it is also possible, in reality, to shoot upwards - if you need to print at the bottom of a box.

If you wish to change the angle, you must however be aware that the heights listed above are no longer valid.

## Connecting the cables

The cables you need to connect the printer has been included in the box. Other connections such as start sensor and encoder may not be included, depending on what you ordered.

With your printer system, you either have an IPC (stainless steel computer) or a PCIPCB controller board to put in your own computer. Since the IPC has the same controller board inside, the connectors are the same - the difference only being that you don't need to make the internal connections in the IPC. Both cases are explained here.

### Connecting the IPC to the printer

Once you have mounted the card inside your computer - or, if you have an IPC, you must connect the controller with the printers and the external accessories such as start switch, encoder and terminal.

Please follow this diagram for the connections:

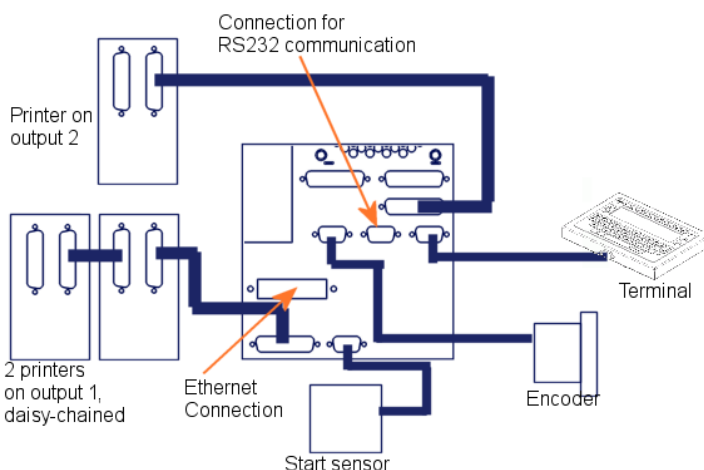

The picture shows a typical setup with connections from the back of the IPC.

The two printers on output 1 are daisy-chained, and therefore share the same data line. This could for example be two 35-mm printers.

The RS232 is not connected, and there is no network connected.

The *optional* terminal and encoder are also connected to the IPC.

Figure 3: Connecting the system

- Remember that you connect max 70 mm print height per output - for example 4 x 17,5 mm (daisy chained) or 1 x 70 mm.
- It makes no difference which of the 2 connectors you use in the printer
- Printers on the same output can either print the same data or different data. Which is decided inside the printer by moving the connectors to the heads (see technical reference).
- Cable length recommended max 5 meter.

## Mounting and connecting PCIPCB controller board

This section is only necessary if you have a PCIPCB board and want to mount it in your own computer.

You need a computer with an ISA slot, and at least 2 additional free slot spaces.

Mount the card inside the computer, fasten the bracket securely and plug in the power for the card. You need a power connector for a hard disc drive.

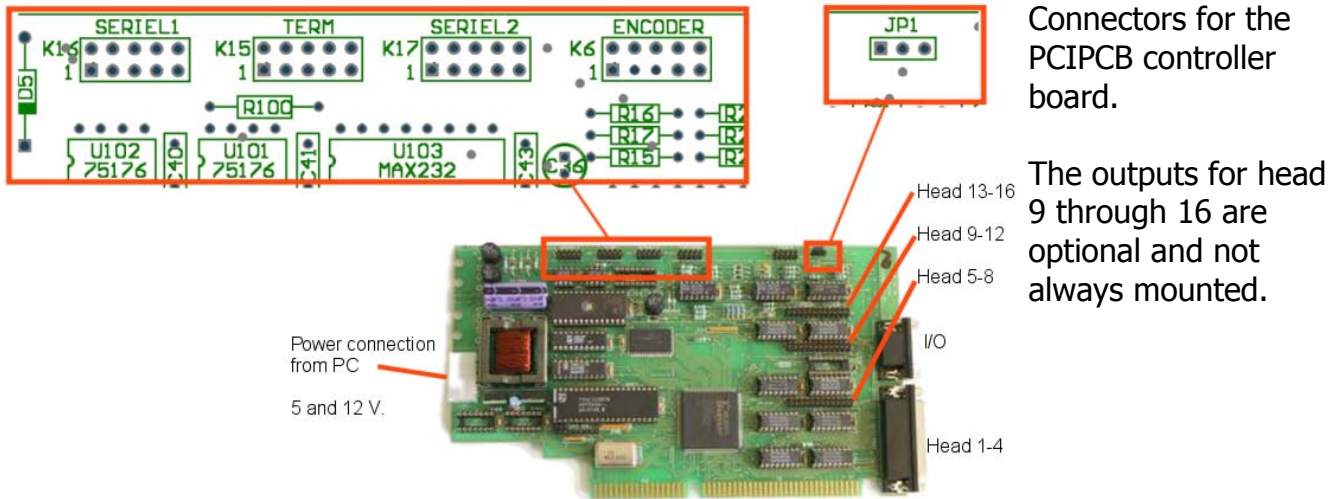

Connectors for the PCIPCB controller board.

The outputs for head 9 through 16 are optional and not always mounted.

Figure 4: Connectors for PCIPCB board

When you receive the PCIPCB controller board, you will also have included a set of brackets to mount in your own computer. The brackets are fitted with a SUB-D connector connected to a 10 or 26-pin header connector that fits the controller board.

Notice the direction of pin1. **The red wire on the flat cable is towards pin 1.**

The table below gives you an overview of the connectors included in the mount kit for the PCIPCB board. The rows are organized in the same way the brackets are mounted.

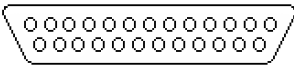
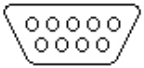
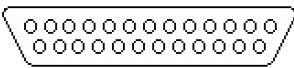
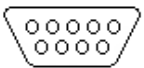
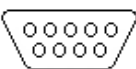
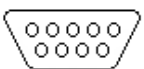
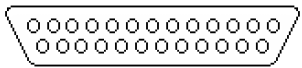
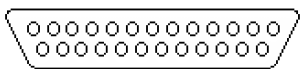
 Head 1-4 (F)	 I/O (F)	<p><b>Back of PCIPCB board.</b>          First output.          I/O for the start sensor.</p>
 Head 5-8 (F)	 RS232 (M)	<p>The second output (70 mm data): connect to corresponding header on the board.          Serial connection. (RS232). Connect to <b>SERIAL2</b> on the board. (Serial1 not used!)</p>
 Encoder (F)	 Terminal (M)	<p>Female connector for the encoder, either NPN or PNP, 10-30 volts or 5 volt. Connect to <b>encoder</b> header on the board          Male connector for the HSA terminal. Connect to <b>terminal</b> header on the board.</p>
 Head 9-12 (F)		<p><b>Optional</b> 3rd output (70 mm data). connect to corresponding header on the board, if mounted.</p>
 Head 13-16 (F)		<p><b>Optional</b> 4th output (70 mm data). connect to corresponding header on the board, if mounted.</p>

## Mounting the ink bottle, starting up the system

From here on it is assumed that your printer is connected to the controller and other accessories such as encoder / start sensor.

The Xaar print engines need to be "primed" before they can function correctly. This term means that you must have the tubes going to the head, and the head itself, filled with ink. The object is to push ink through the system until no more air is coming out of the head.

- **Remove the black transport plug and install an the hand pump.** Press the blue ring to release the transport plug.
- Mount the inkbottle by unscrewing the empty bottle and mounting the full bottle.
- Power-on the system. You can hear the pump starts running. Let it run without doing anything. (Until the green LED stops flashing).
- Press the red button and let the pump run again until the green LED stops flashing.
- Mount the hand pump and close the valve. (turn *clock-wise*)
- Press the red button once again to make the pump run while priming the head.
- Start pumping the hand pump to make a continuing pressure to prime the head.
- Slowly continue to pump the hand pump almost like a respiration rate. You will probably see air bobbles coming out from the nozzles every time you make a new pump movement.
- Continue to make this pump cycle until no more air are coming out from the nozzles and then a few more pump movements. (typically 30 to 50 sec.). You will see the ink flow down the front of the head.
- Slowly open the valve to release the pressure from the system. If you open the valve to fast, you will make "a standing wave" in the ink-system sucking air backwards in to the nozzles.
- Once properly primed, mount the air filter in the printer.

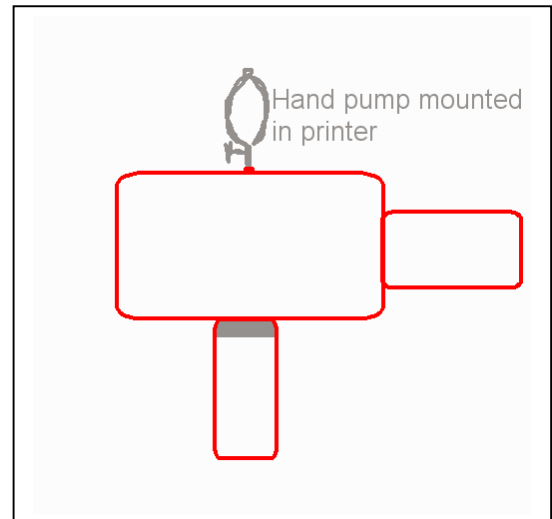

The procedure is the same no matter if the system is primed for the first time or if the system is re-primed because it has been run out of ink.

To test the success of the priming, take a piece of paper and move it past the head while holding down the **black** button on the ink supply. You should see a solid pattern without any white lines. A speed of about 30-40 cm / second is good for this test.

# Testing the function of the system

## Creating the first OBJ INKdraw message

The software "OBJ INKdraw" is required to create messages on your printer. Typically this will be pre-installed in the IPC and will start automatically with the computer.

A screenshot is shown here with the printed message highlighted.

The best way to test the printer is to load a pre-defined test message; these should be included with the installation.

For test purposes, set the printer in velocity mode

- Press [F9] or the parameters button
- Select "Print modes"
- Select "Velocity" and enter a number in the "m/min" box. A value of about 15-25 is good for tests.
- Press OK

Now you just need to press "F10" to activate print mode. You will see the screen change to indicate the print mode active.

Activate the start switch / sensor while you pass the product past the printer.

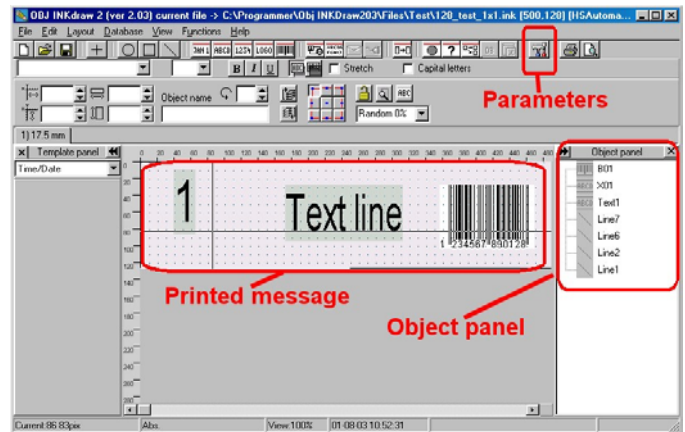



Figure 5 : OBJ INKdraw

---

 Do not worry if the printout is misaligned or mirrored. This can be corrected through settings.

---

# Maintenance and service

## Cleaning the printer

When cleaning the printer, it is important to separate the nozzles and the rest of the printer. The two parts must be cleaned in different ways:

- **The stainless steel** parts may be cleaned with a lint-free paper tissue or a cloth. It is also OK to carefully dry off the printer around the nozzles.
- **The nozzles** must be cleaned with the blue swab that is supplied with the printer, or available as spare part.  
While priming out a bit of ink (use the hand pump), rub gently in the **up and down** direction, along the nozzle row. **Never** rub sideways.  
Also you can use a piece of lint free tissue but you have to be absolutely sure that the material used for wiping is completely lint free to avoid blocking a nozzle.

## Changing the ink bottle

The printing system with the ink bottle mounted underneath allows you to change ink bottle during production. Changing the ink bottle may happen during production. Simply unscrew the old bottle and replace it with a new bottle. After the new bottle has been mounted, press the red button to let the pump run a few minutes, to fill up the ink chamber. Make sure that the new bottle is screwed on tightly in the thread.

## Using solvent-based inks

Compared to standard oil-based inks, the solvent-based inks allow you to print on non-porous surfaces like plastics and glass. However, the ability to dry on non-porous surfaces also allows the ink to dry in the head. Therefore, special care must be taken when you want to use solvent-based inks

### During print activity

It is important to keep the ink in activity all the time. Do this by activating the spit function in OBJ INKdraw. The spit function will print once with all nozzles each time it is activated. Follow these steps to activate:

- F9 (Parameters)
- Go to the "purge" section
- Alter the numbers under "spitrate (sec)" and "burst"  
spitrate = how many seconds between activation of function  
burst = how many spits that is done with every activation

If the spit function is not desirable for you, for example because you print on a web, you can experiment with the "Tickle" function. This function will lower the voltage to the head and keep

the nozzles moving. The higher the number (1-15), the higher the frequency will be. Putting "0" will disable the function.

We have information that a tickle function might have a positive influence when using solvent-based inks. The effect will depend on the ink and the environment. The function has been implemented and electrically tested. We did *not* make tests with different inks - it is up to the user to test for effects using the tickle function in a given situation.

### Stopping print overnight

The best solution is to leave the printer on and activate the spit function (the ink consumption is very low). For example, let the printer spit into a bag or a sponge.

If this is not possible, follow these steps:

- Take a piece of PE plastic film and press it lightly against the nozzles while you do a purge (the black button). The surface tension will make the plastic stick to the print head.
- Take a lint-free cloth
- Make it wet with flushing solution appropriate for the solvent ink
- Put the cloth into the yellow cup supplied with the head
- Put the cup over the print head

This method is also useable over f.x. a weekend.

### Stopping the printer for a longer time

If you need to stop for a longer time, you need to get the ink out of the print head. The easiest and simplest solution is as follows:

- Remove the side panel for the printer
- Dismount the plastic tube going to the ink chamber.
- Using a syringe, first blow air through the head, then appropriate flushing solution (until all the ink is gone), then air again.
- Remount the plastic tube
- Finally, close the hole for the purge bulb with the supplied plastic stick.
- Cap the head

---

#### **Notice about warranty**

In general, there is no warranty on heads that are printing with non-XaarJet inks (including solvent-based inks). This is also the case if the head is broken due to mishandling of solvent-based inks. Any warranty issue is handled by XaarJet UK, who makes the final decision about warranty.

---

## **Critical components / spare parts.**

The ideal situation when talking about spare parts is to have an extra printer, in case the one in production should fail. But, since that may not always be possible, here is a list of suggested spare parts that should be on stock:

- Blue swaps for cleaning the printer. Available in packs of 10.
- Extra Purge Bulb
- Tubing, 4 and 6 mm.
- Extra 12 V ink pump
- Extra empty ink bottles (0,5 Liter / 1 Liter)
- Spare controller board
- Fuses type TR5 (Time Lag), 1A

# Fault diagnosis

If you do not see any print from your printer as expected, follow this table to track down the error.

## Printer

Symptom	Possible reason	Suggested solutions
White lines in the print	Missing nozzles	Make sure the head is in correct height compared to ink supply.  Prime the head and make sure all air is out of the head.  If the printer is in a dusty environment, press a bit of ink out with the hand pump, and rub gently with supplied blue swab
Ink dripping from head	Incorrect height	Make sure the head is in correct height compared to ink supply.  Check fastening of tubes to avoid getting air into the engine.
Constant low ink level alarm	Ink level measurement not calibrated	Calibrate measurement according to instructions later in this manual.
White lines when printing big, black messages	The pump needs to pump more ink	Decrease the pump pause, see later about interactive printer functions.
Printout is mirrored	Print direction not correctly set	Change setting in OBJ INKdraw and save message
Print engines start at different times	Engines / Heads not aligned	Align heads and engines according to instructions
No print	No photocell signal and/or no encoder signal  Printer not primed  No 35V to printer (Fuse)	Test I/O functions in OBJ INKdraw ([F9]->Test I/O)  Prime the printer.  Test fuse for 35V to head (on controller board)
Print is longer / shorter than expected, or irregular in print direction	Is velocity set correctly when using velocity mode  Do encoder settings correspond to encoder used	Measure speed of conveyor accurately to check  Did you set modular mode when you meant to use position mode ?  Is the mm/pulse correctly set ? (circumference / ppr)
Print is 1/2 or 1/4 of what is should be in length	Quadrature set	You might have activated quadrature, but not adjusted the mm/pulse accordingly.
Print does not start until the start sensor is released	Negative vs. positive edge	Select the correct setting for your start sensor in OBJ INKdraw parameters

## Controller

<b>Symptom</b>	<b>Possible reason</b>	<b>Suggested solutions</b>
Complains about no monitor / keyboard / mouse on startup	Windows® has not been told to ignore these errors	Change settings in BIOS ("Halt on no errors") for monitor / keyboard. Change setting in Windows when starting without mouse.
OBJ INKdraw does not start	Shortcut not correct	Establish the correct shortcut to the "Startup" folder.
Terminal says "Restart system" after some time	Terminal not activated in OBJ INKdraw	Go to preferences->Serial, and choose Terminal
"Priviledged instruction" in Windows 2000 / XP	Did not install driver for controller board	Install driver, pls. see instructions for driver.

# Reference

## Interactive functions on the ink supply

The automatic ink system has some built-in interactive functions, through which you can adjust settings related to the printer. Notice that the XaarJet 500 has 1 function that is not on the XaarJet 128 printers.

### Start of interactive mode

- Hold down both buttons until both LEDs are blinking. When the buttons are released, both LEDs are turned off.

From here you have 2 (or 3) different functions, depending on the type of printer:

### Adjust the length of the pump cycle

Sets the length of the time the pump is running. Use this function if you print an image that uses a lot of ink, where you empty the ink chambers before the pump can fill them again.

- From interactive mode, activate the black button until both LEDs are blinking. The LEDs are turned off when the button is released.
- The yellow LED is blinking according to the selected level. The faster, the more the pump will be working
- By pressing the black button, the next higher level will be selected. There is a total of 6 levels; the green lamp will be on at the lowest level (longest time between pump activity). Level 3 is the default setting.
- Press the red button to go back to normal function. The pump will run a normal cycle after this.

### Adjust / calibrate the measurement of low ink warning

The low ink alarm is automatically calculated, but for the best measurement it may be necessary to re-calibrate the printer. Notice that the order (full / empty bottle) is not important, since the difference is calculated.

- Dismount the ink bottle
- From interactive mode, press both buttons until both LEDs are blinking. When the buttons are released, the LEDs are turned off.
- The empty condition is measured. When finished, both LEDs are turned on.
- Mount a full ink bottle
- Press the black button until both LEDs turn off.
- The LEDs are blinking, to indicate that the measurement is complete

- Press the red button to return to normal function. The pump will start running.

#### Adjust the print direction (XaarJet 500 only)

The XaarJet 500 allows you to choose between two different ways of shooting with the nozzles. The print quality will depend on this setting.

- From interactive mode, press the red button. One lamp will be lit, the other not.
- Press the black button to toggle between the two directions. The light will change accordingly.
- Press the red button to exit. The pump will run.

## How to properly empty and pack printers for shipment

Often when printers are shipped, they are insufficiently packed and not always emptied. Since shipping companies often do not respect orientation arrows, this will often result in a printer that is full of ink outside. **Follow this guide** when packing the printers for shipment.

- Mount an empty bottle on the printer
- Mount prime bulb and disconnect the cables
- Tilt the printer in a 45° angle with the engine pointing downwards. In this position, pump with the bulb until no more ink is coming out of the head. (Remember to do this over a container suitable for the ink).
- Some ink may have come into the bottle. Empty it into the container.
- Re-mount the empty bottle, make sure it is tightly fitted to the printer
- Remove the purge bulb and mount the plastic part that closes the hole. It has been included with the printer. Make sure it is all the way in. ("click" sound)
- Carefully dry off the head. **Only use a blue cleaning swab for the nozzles.**
- Wrap the head as follows:

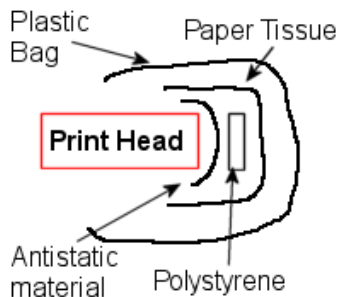

Figure 6 : Wrapping the head

Wrapping the head for shipment:

Use the following from the nozzles and out:

- Antistatic material
- Polystyrene
- Paper Tissue
- A plastic bag to cover the entire head

Close the plastic bag with tape around the back of the head.

- Wrap paper tissue around the connection between ink bottle and the printer (the black plastic thread). Secure with tape
- Place the printer in the box as follows:

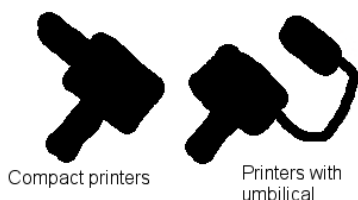

Figure 7: placing the printers in the box

Box with printers viewed from the *side* of the box.

When you place the printers, make sure the nozzles are pointing upwards.

- Use a proper size box, and remember to use protective material such as foam or polystyrene chips.
- Put orientation arrows and "fragile" signs on the box.

# Technical Specifications

## Electrical specifications:

Sensor supply (VIO) – Minimum:	3 V
Sensor supply (VIO) – Maximum:	36 V
Encoder supply (VENC) – Minimum:	3 V
Encoder supply (VENC) – Maximum:	36 V
Encoder input – Frequency maximum:	25 kHz
Sensor and encoder supply (VEXT) Maximum:	500 mA
Main supply @ 115V – Minimum:	104 V / 60 Hz.
Main supply @ 115V – Maximum:	121 V / 60 Hz.
Main supply @ 230V – Minimum:	207 V / 50 Hz.
Main supply @ 230V – Maximum:	243 V / 50 Hz.
Main power consumption – Typical:	20 Watt

## Ink-system:

Inkbottles:	0,5 or 1 Liter.
Umbilical length - Minimum:	0 meters (compact)
Umbilical length - Maximum:	1 meters

## Nominal print data

XJ128:	34,97 m/ minute, 185 dpi
XJ500:	30 m/minute, 180 dpi
Throw distance – Optimal:	1 mm
Throw distance – Maximum:	3 - 4 mm

## Acceptable work temperature range

Operational temperature on the heatsink of the print engine.	
Minimum:	0 degrees Celsius.
Maximum:	40 degrees Celsius.

---

 The heads for printing with UV are different. You must specify this use when ordering.

---

# Warranty statements

## General system warranty

HS Automatic ApS, manufacturer of the XaarJet based print systems, provides a general warranty of 1 year on all hardware (controller, electronic and mechanical parts). This warranty is ex works.

## Print engine warranty

The print engine is not covered by this general warranty. On the engine, HS Automatic ApS gives a warranty of maximum 1 year. This warranty is, however, depending on the image that is printed.

There is a minimum warranty of  $4 \cdot 10^9$  drops per nozzle in the XJ500 engine;  $2 \cdot 10^9$  drops per nozzle in the XJ128 engine. These are the minimum requirements, they typically outperform this by a factor 3-4.

If the customer needs to have the expected lifetime evaluated based on an actual picture, Xaar Plc. offers to do this within 24 hours.

In cases of warranty, the engine will be sent to Xaar Plc, who makes the final decision.

Finally, in cases where the head has been printing with a non-official XaarJet ink, all warranty on the engine will be void.